

PRODUCT DATA SHEET

A) SPECIFICATIONS

1 Cable clamp. Material: PA6-VO, black colour, self extinguishing, halogen free (according to UL94-VO).

B) OPERATING TEMPERATURE

Working temperature : -40°C +125°C.
Installation temperature : -20°C +60°C.

C) DELIVERY MODALITIES

Packing in boxes. Label indicating: product code, article, quantity, production batch, FIMO logo and figure. (Customer code on request).

D) MOUNTING INSTRUCTIONS

IT043

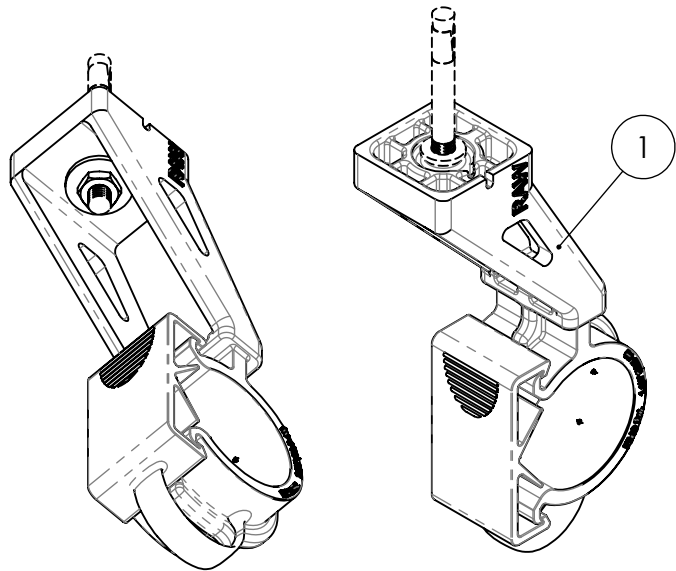
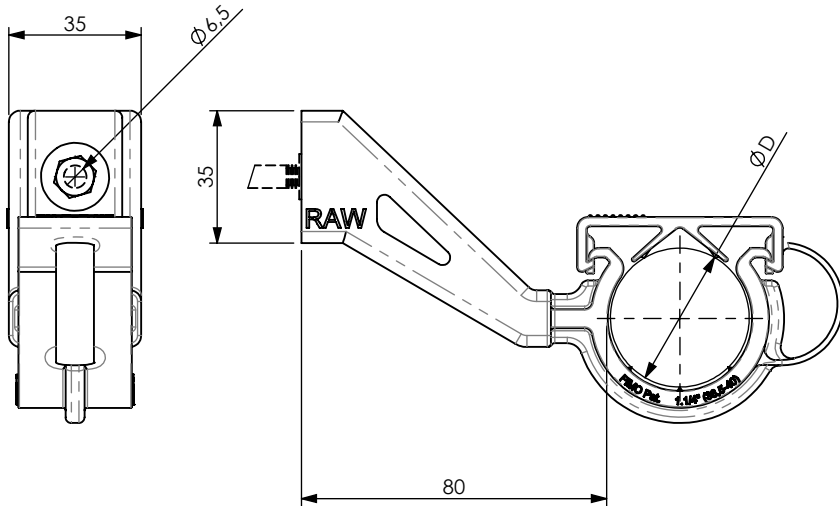

code	6150010114
article	RAW 1.1/4"-80

D		
38.5-40	50	0.0618kg

RI	DATE	DR	DATE	AP	Description:
02					RAW 1.1/4"-80 Radiating Cable Clamps
01					
00	02/12/2016	E.B.	02/12/2016	A.V.	
1 ST EMISSION					
					<i>Use: Horizontal or vertical installation of radiating cables in tunnel</i> <i>* Suitable for installation in high speed railway tunnel application (400 km/h)</i>