

PRODUCT DATA SHEET

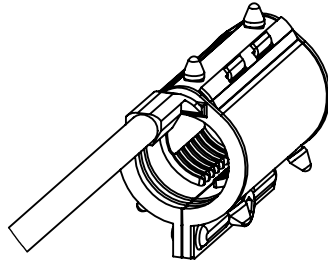
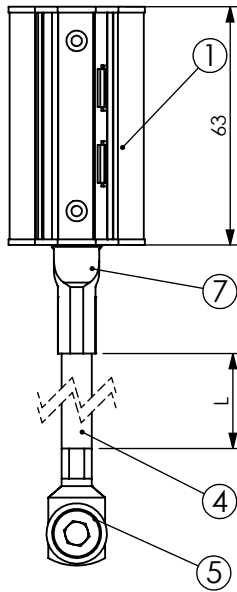
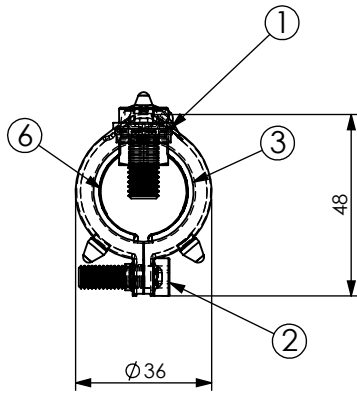

A) SPECIFICATIONS

- 1 Shell: Stainless steel.
- 2 Hexagon socket head Screw: Stainless steel VCI 6x20
- 3 Gasket: Rubber EPDM.
- 4 16sqmm Connection cable: L=500 PE rigid copper cable.
- 5 Cable lug Ø8: Tinned copper. Including earthing screw kit (screw VCI 8x20; nut DAI 8, washers REG 8 + RPI 8/16).
- 6 Inner Contact: Tinned brass.
- 7 Contact bar: Tinned brass.

B) RESISTANCE TESTS

Waterproof test:

IP 68 (FIMO Test according to IEC60529 normative).

Contact Resistance $\leq 1\text{m}\Omega$

Operating Temperature $-40^{\circ}\text{C} +85^{\circ}\text{C}$

C) PACKAGING INFORMATION

Packing in boxes.

Label indicating:

product code, article, quantity,

production batch,



FIMO logo and figure.



(Customer code on request).

D) MOUNTING INSTRUCTIONS

IST 046

code	6115409078
article	KMT 7/8" P E

D	L		
26-28	500	10	0.2576kg

RI	DATE	DR	DATE	AP	Description:
02					Grounding Kit
01					
00	17/12/2014	E.B.	17/12/2014	A.V.	
1 ST EMISSION					
 Building Sustainable Innovation					Use: Earthing of coaxial cables.