

# PRODUCT DATA SHEET

## A) SPECIFICATIONS

- 1 Cable clamp. Material: PA6-VO, black colour, self extinguishing, halogen free (according to UL94-VO).
- 2 Stainless Steel RSD safety clamp

## B) OPERATING TEMPERATURE

Working temperature : -40°C +125°C.  
Installation temperature : -20°C +60°C.

## C) DELIVERY MODALITIES

Packing in boxes. Label indicating: product code, article, quantity, production batch, FIMO logo and figure. ( Customer code on request ).

## D) MOUNTING INSTRUCTIONS

IT043

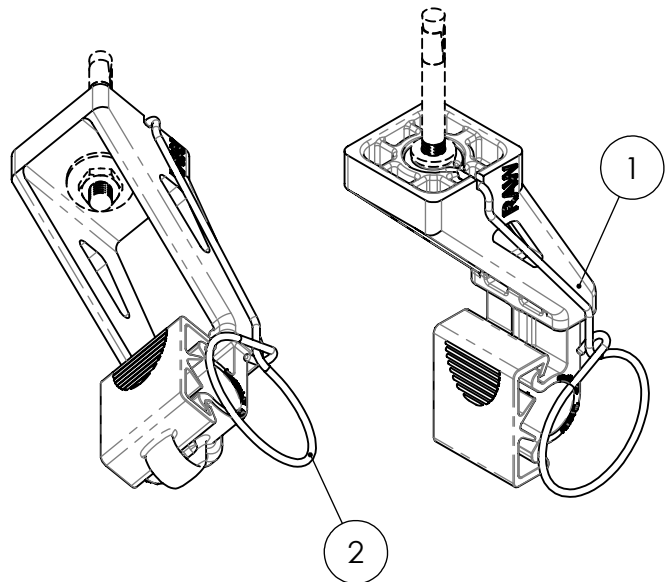
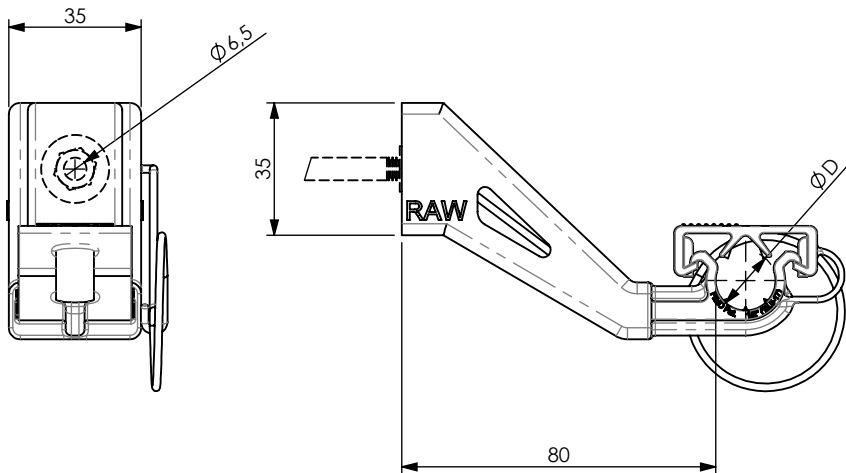

code	<b>6150210012</b>
article	RAW 1/2"-80 + RSD 1/2"-80

<b>D</b>		
15.5-17	50	0.0542kg

RI	DATE	DR	DATE	AP	Description:  <b>RAW 1/2"-80 + RSD 1/2"-80 Radiating Cable Clamps</b>
02					
01					
00	05/12/2016	E.B.	05/12/2016	A.V.	
1 <sup>ST</sup> EMISSION					
					Use: Horizontal or vertical installation of radiating cables in tunnel  * Suitable for installation in high speed railway tunnel application (400 km/h)